

Aluminum Door Shoe

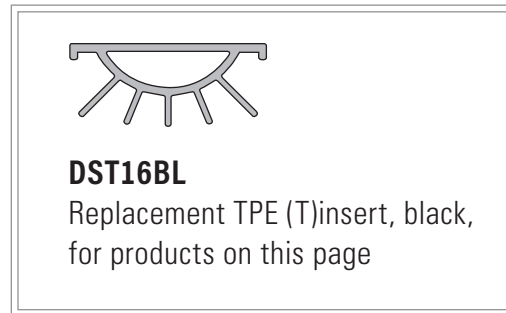
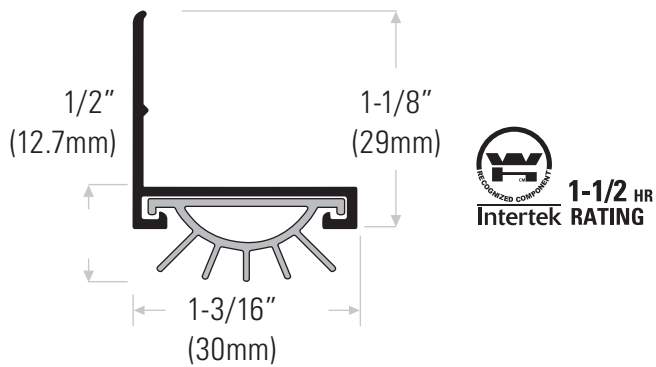

DS211AT Extruded aluminum mill finish with TPE (T) insert

DS211DT Bronze anodized

Door shoe is supplied with punched holes and screws and is available in the following NET lengths: 36" (914mm) & 48" (1219mm). Custom lengths available, call for manufacturing time.