

Retrofit Door Weathersealing

Superior Plus Weathersealing Door Kit E-Lon® by Foam Tite®

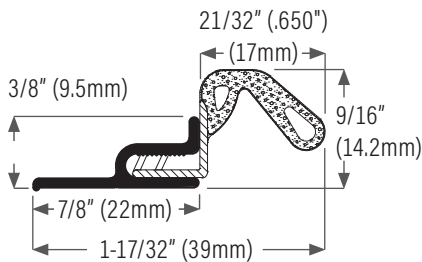

DS422B Extruded aluminum painted brown with gasket insert, brown

DS422C Clear anodized with black gasket insert

DS422W Painted white with white gasket insert

Available in sets of

1/36" x 2/81" (914 x 2057mm) single door set

1/36" x 2/84" (914 x 2134mm) single door set

1/72" x 2/84" (2057 x 2134mm) double door set

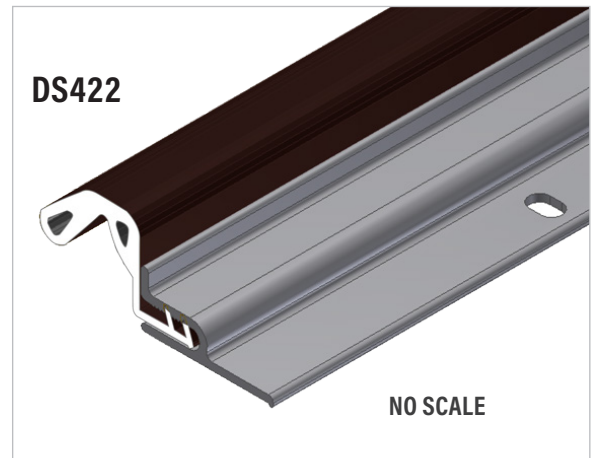

DS422

Extruded aluminum painted brown or white, with matching brown or white foam-tight compression gasket. Also available clear anodized extrusion with black foam-tight compression gasket.

Advantages Of Foam-Tight Kerf Gasket

- » Closed cell foam structure: high resistance to water absorption & eliminates wicking.
- » Seamless elastomeric skin: provides long life, resilience, & durability. Puncture & tear resistant, outlasts & outperforms all other replacement weathersealing.
- » Superior resistance to compression set: operating forces remain constant over a wide compression range, helping doors exceed all industry requirements.
- » Performance: independent tests have shown foam-tight performs like new under all temperature.
- » Punched/slotted holes.
- » Plated screws supplied with white sets.
- » Antique bronze plated screws supplied with brown sets.
- » Foam-Tight gasket easily replaceable, pull out the old & push in the new.